

8 7 6 5 4 3 2 1

STANDARD INJECTION MOLDING COMPANY, INC.®

REVISIONS			
REV.	DESCRIPTION	DATE	APPROVED

F

F

E

E

D

D

C

C

B

B

A

A

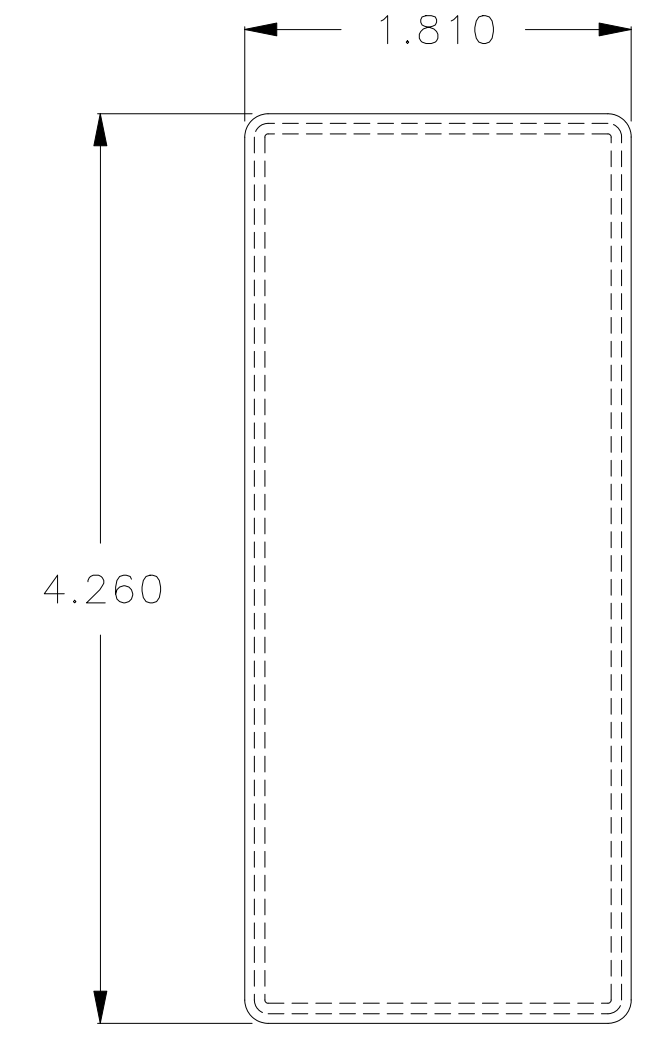
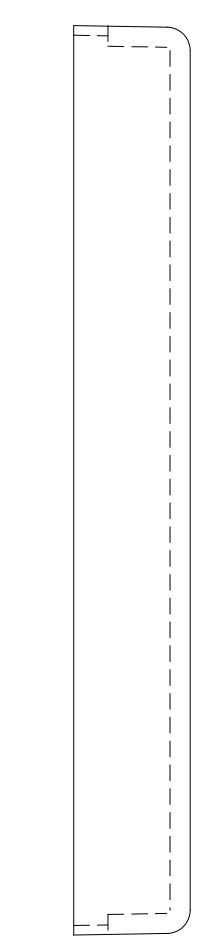
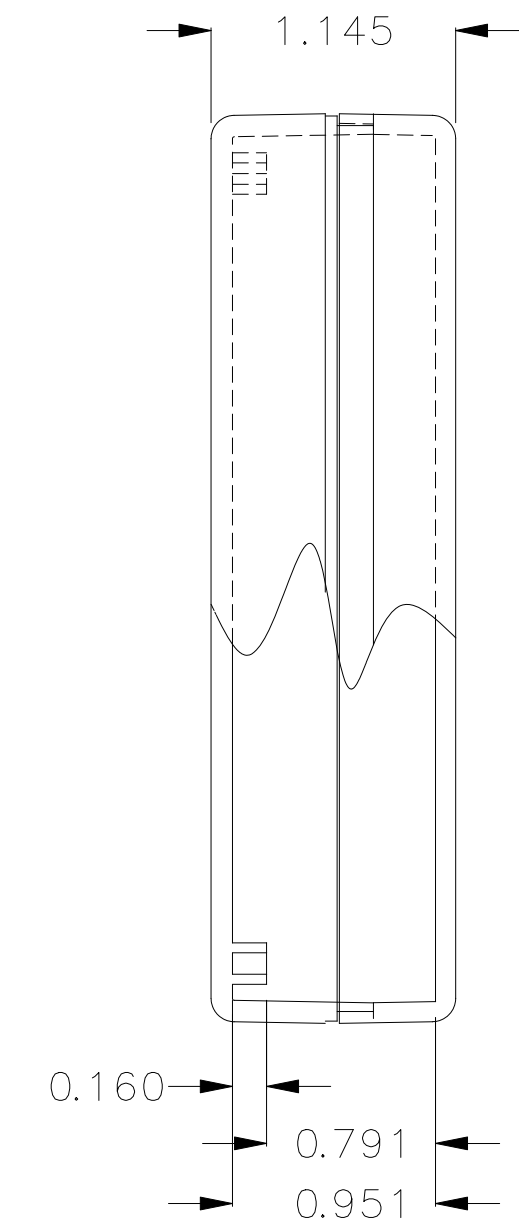
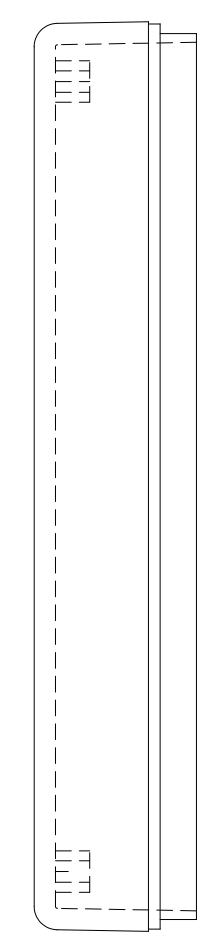
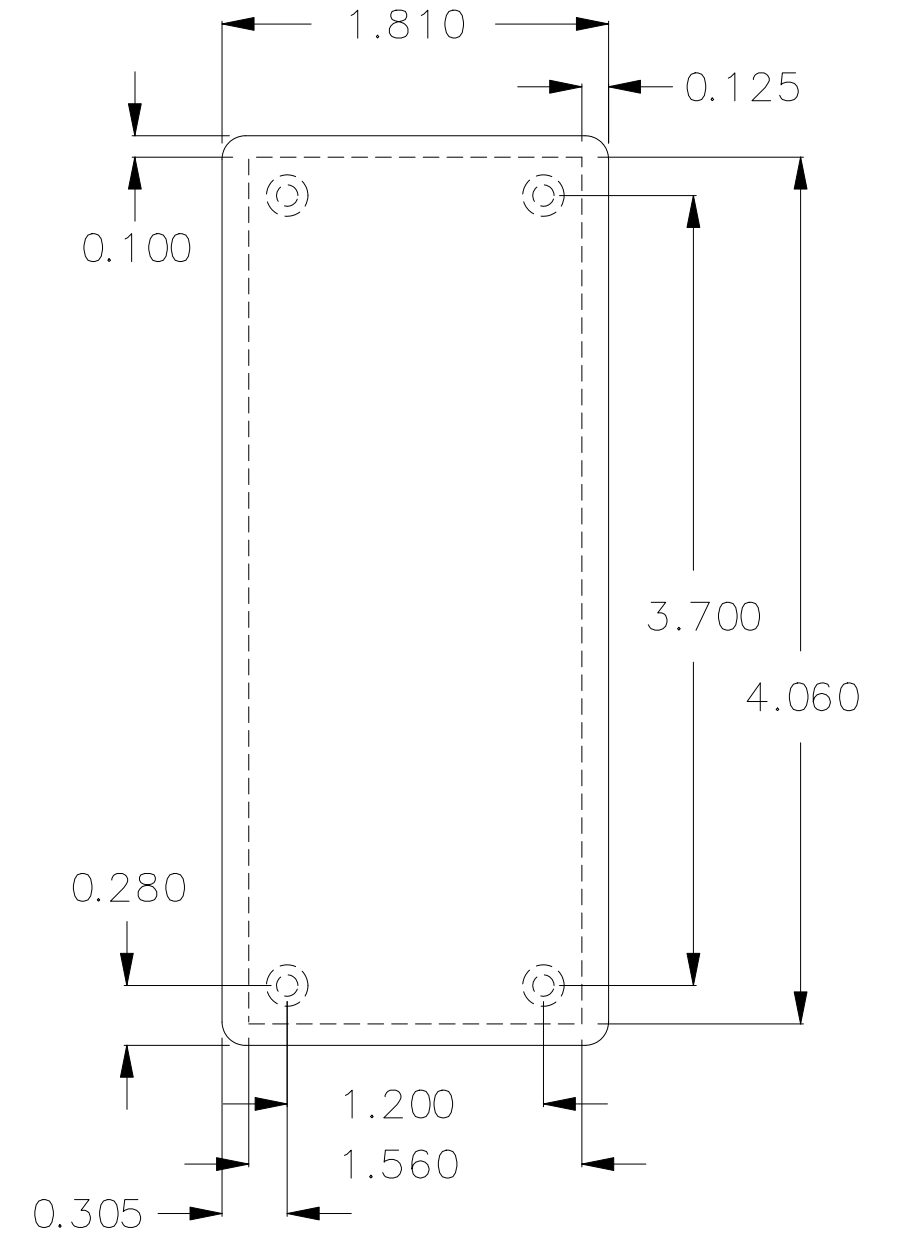
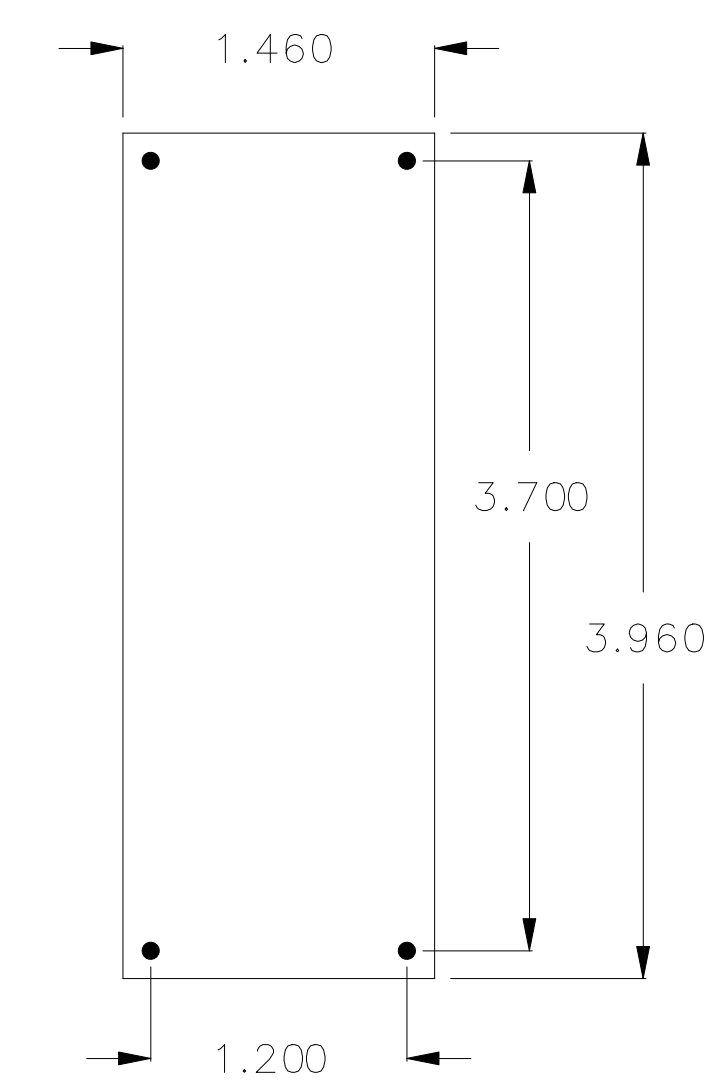
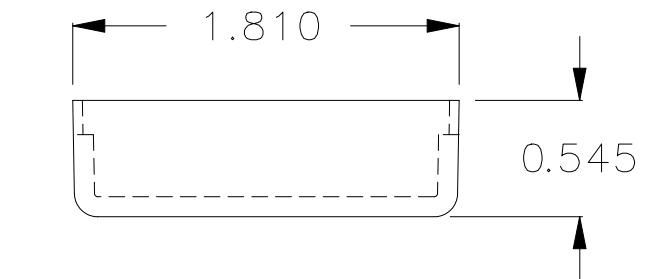
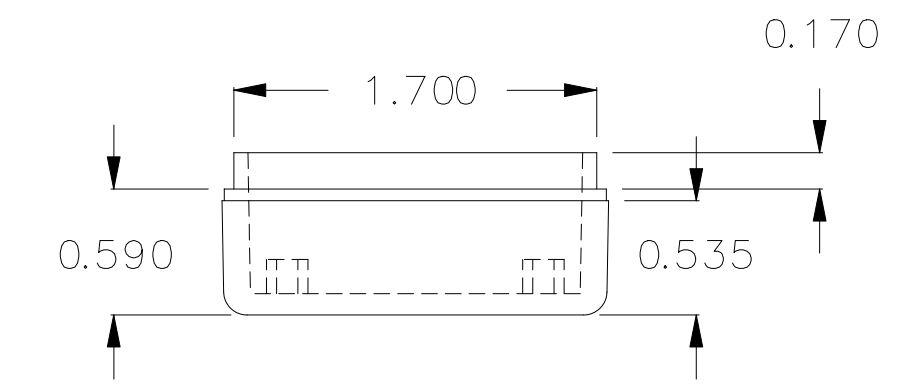

Circuit Board Layout  
 Note:  
 Recommended hole size for  
 circuit board is .090 - .125 Dia.

UNLESS OTHERWISE SPECIFIED  
 DIMENSIONS ARE IN INCHES.  
 TOLERANCES ARE ± .015  
 UNLESS OTHERWISE STATED  
 ANGLES ± .5°  
 MATERIAL  
 ABS  
 FINISH  
 Texture  
 CAD GENERATED DRAWING  
 DO NOT UPDATE MANUALLY

INCLUDED HARDWARE			
Qty.	SCREWS	Qty.	FEET

**SIMCO**  
**111X14**

SIZE: D DRAWING NO. REV.  
 SCALE: CAD FILE: SHEET OF

8 7 6 5 4 3 2 1